

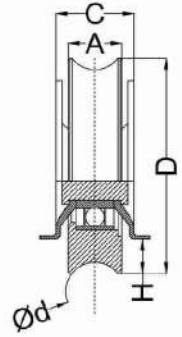

Sliding Gate Wheel
with Double Plates
(Single Bearing, U Groove)



PRODUCT CODE	D mm	A	C	H	d	WEIGHT(g)	CAPACITY(kg)
AZ C1U60 R16	58	17	28	7	16.5	330	125

Sliding Gate Wheel
with Double Plates
(Double Bearing, U Groove)

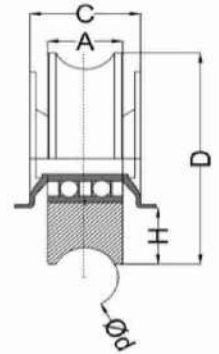

PRODUCT CODE	D mm	A	C	H	d	WEIGHT(g)	CAPACITY(kg)
AZ C2U80 R20	78	25	37	16	20.5	737	200
AZ C2U100 R20	98	25	38	17	20.5	1339	300
AZ C2U120 R20	118	30	42	22	20.5	2412	400

Sliding Gate Wheel
with Interior Bracket
(Single Bearing, U Groove)

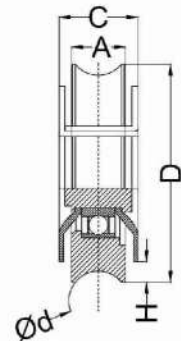

PRODUCT CODE	D mm	A	C	H	d	WEIGHT(g)	CAPACITY(kg)
AZ CN1U60 R16	58	17	26	10	16.5	360	125

Sliding Gate Wheel with Interior Bracket
(Double Bearing, U Groove)

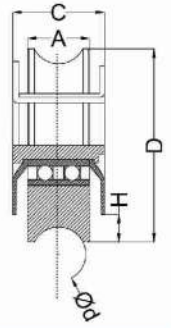

PRODUCT CODE	D mm	A	C	H	d	WEIGHT(g)	CAPACITY(kg)
AZ CN2U80 R20	78	25	33	12	20.5	821	200
AZ CN2U100 R20	98	25	33	13	20.5	1359	300

Sliding Gate Wheel with Bolt
(Single Bearing, U Groove)

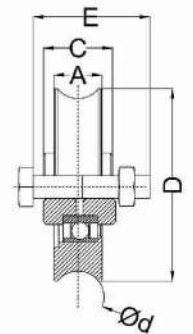

PRODUCT CODE	D mm	A	C	E	d	WEIGHT(g)	CAPACITY(kg)
AZ N1U60 R16	58	17	24	M10x55	16.5	294	125

Sliding Gate Wheel with Bolt
(Double Bearing, U Groove)

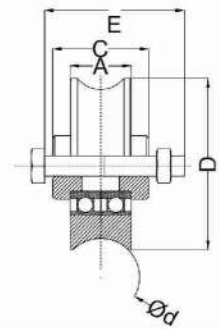

PRODUCT CODE	D mm	A	C	E	d	WEIGHT(g)	CAPACITY(kg)
AZ N2U80 R20	78	25	31	M10x55	20.5	645	200
AZ N2U100 R20	98	25	30	M14x70	20.5	1168	300
AZ N2U120 R20	118	30	42	M14x70	20.5	2122	400
AZ N2U160 R20	158	30	42	M14x70	20.5	4018	500
AZ N2U180 R20	178	30	42	M14x70	20.5	5236	600

Sliding Gate SS304 Wheel with Interior Bracket
(Single Bearing, U Groove)

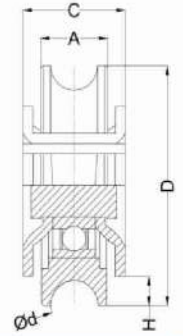

PRODUCT CODE	D mm	A	C	H	d	WEIGHT(g)	CAPACITY(kg)
AZ D1U60R16SS SS304	58	17	26	10	16.5	360	125
AZ D1U80R16SS SS304	78	20	32	13.5	16.5	672	200

Sliding Gate SS304 Wheel with Interior Bracket
(Double Bearing, U Groove)

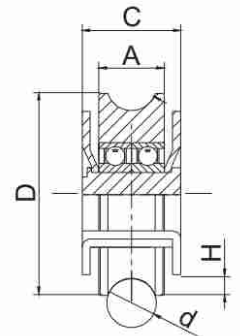

PRODUCT CODE	D mm	A	C	H	d	WEIGHT(g)	CAPACITY(kg)
AZ D2U100R20SS SS304	98	25	33	13	20.5	1359	350

Sliding Gate Double Wheel with Drilled Fixing Plate

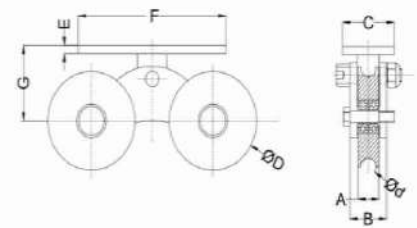

PRODUCT CODE	D mm	A	B	C	E	F	G	d	WEIGHT(g)	CAPACITY(kg)
AZ HL05A	118	28	50	70	10	200	90	20	7500	850

Sliding Gate Track
Drilled Surface Fixing
(U Groove)

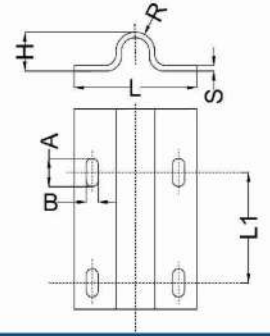

PRODUCT CODE	H mm	H	S	A x B	L1	R	WEIGHT(g)	CAPACITY(kg)
AZ TB16	55	15	3	11 x 6	300	16	1520	800
AZ TB20	55	15	3.5	11 x 6	300	20	1760	1000
AZ TSS20A SS304	55	15	3.5	11 x 6	300	20	1760	1750

Sliding Gate Track
Concreted Fixing
(U Shape)

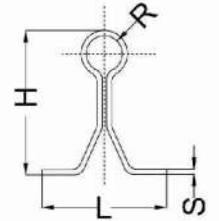

PRODUCT CODE	L mm	H	R	S	WEIGHT(g)	CAPACITY(kg)
AZ TW20	65	60	20	3.5	4370	1600

Nylon Roller
(with Bearings)

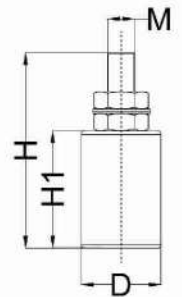

PRODUCT CODE	H mm	H1	M	H	WEIGHT(g)
AZ N50x60	50	60	M16	120	499
AZ N40x100	40	100	M16	135	474

Guide Bracket with
4 Nylon Roller

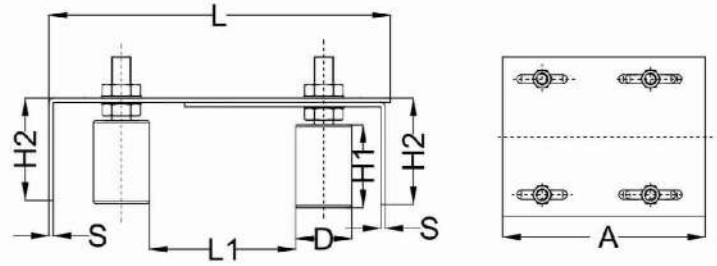

PRODUCT CODE	D mm	H1	A	H	L	L1	S	WEIGHT(g)
AZ GB9A	30	40	200	55	164-208	26-70	2.5	1740
AZ GB9C	40	44	350	68	176-260	19-103	4	5355

Guide Bracket with
2 Nylon Roller

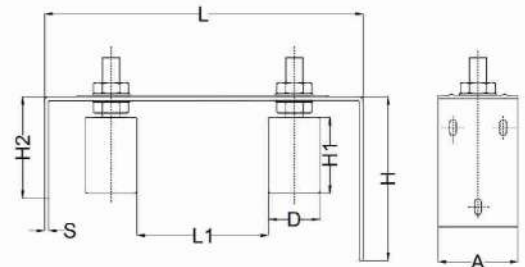

PRODUCT CODE	D mm	H1	A	H2	H	L	L1	S	WEIGHT(g)
AZ GB7C	40	44	68	65	100	200	45-89	4	1175

Gate Stopper with
Base Plate
(Small Rubber)

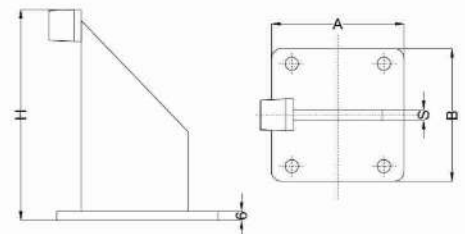

PRODUCT CODE	H mm	A x B	S	WEIGHT(g)
AZ GS2A	146	100 x 100	10	987

Gate Stopper without
Base Plate
(Large Rubber)

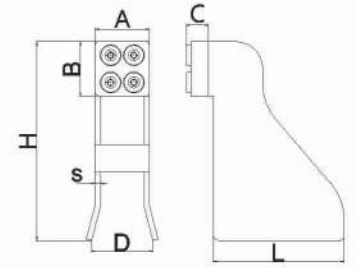

PRODUCT CODE	A	B	C	H	L	S	D	WEIGHT(g)
AZ MX17A	40	40	18	146	100	4	45	657

Telescopic Kit

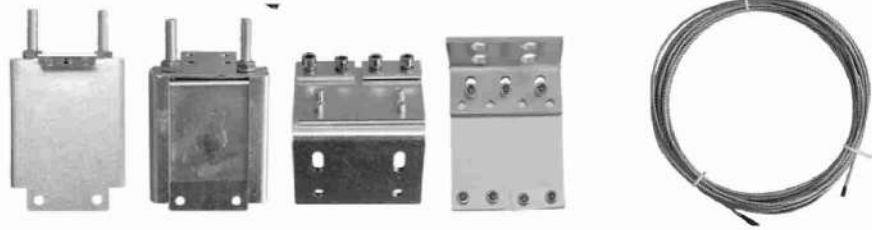

PRODUCT CODE	D mm	A	D	CAPACITY(kg)
AZ TELS01	65	4.5	4	250+250
AZ TELS02	125	6.5	6	400+400
AZ TELS03	175	8.5	8	600+600
AZ TELS04	150	8.5	8	500+500

End Cap with
Nylon Roller

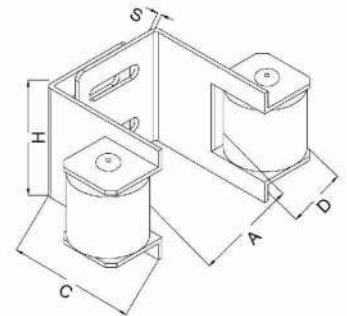

PRODUCT CODE	A mm	H	C	S	D	WEIGHT(g)
AZ EC4A	55-90	80	95	4	40	800

End Cap
Bracket

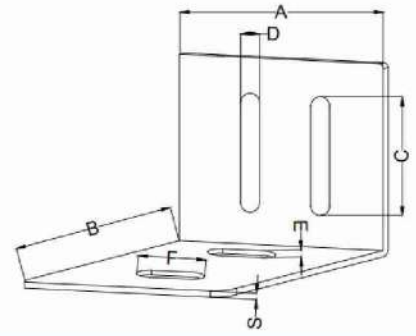

PRODUCT CODE	A mm	B	C	D	E	F	S	WEIGHT(g)
AZ ECL 17 A	130	120	70	10	10	40	5	1098